

CHORUS_Infosheet.



CONCEPTUAL[®] FURNITURE DESIGN

CHORUS
COLLECTION.
Seat height.

Technical sheet

- Ⓐ . Steel tube frame
- Ⓑ . Rubber band
- Ⓒ . High density foam
- Ⓓ . Low density foam

- Steel tube (Diam. 22)
- ▨ Foam
- ▤ Rubber band

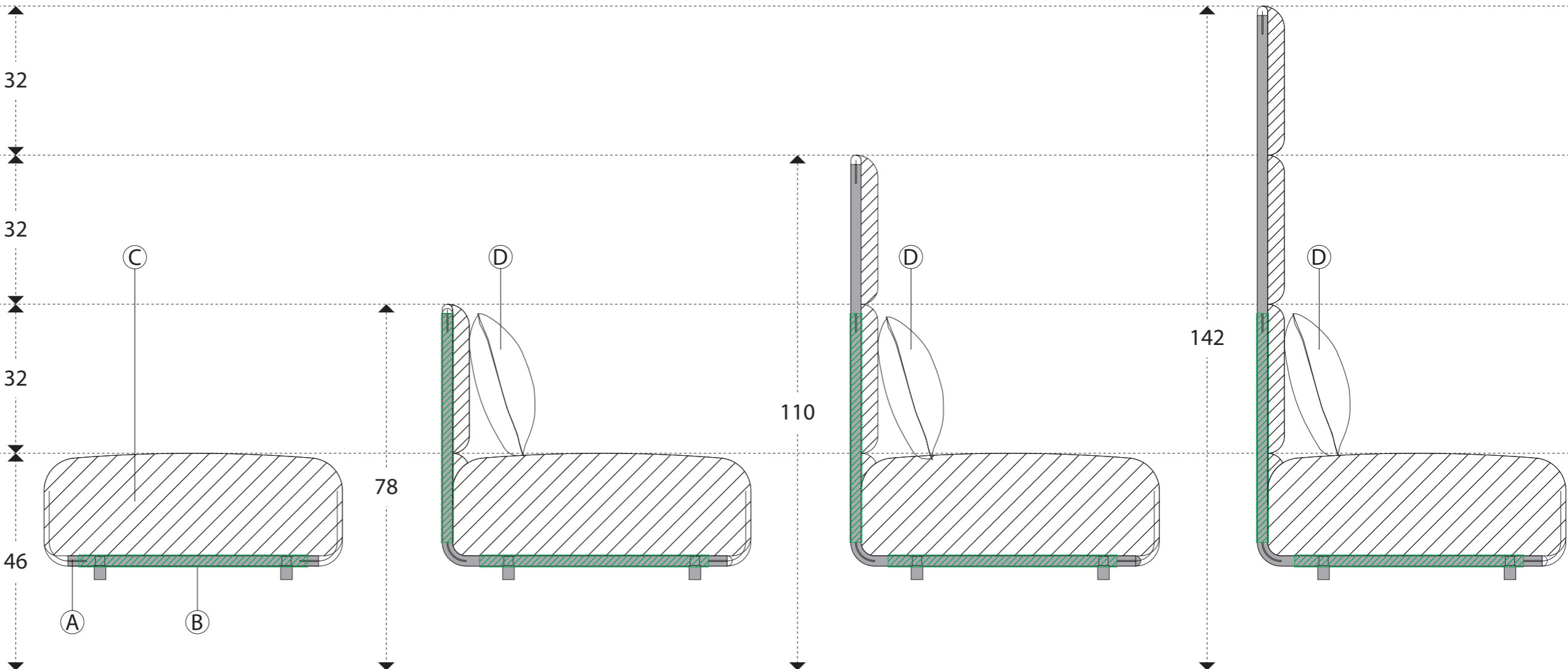

CHARACTERISTICS

FINISHES

SEAT FRAME_ZERO-COLOUR EPOXY FINISH.

POWDER COATING FINISHES

● Zero Colour
Mix of recycled powders coating.
Smooth epoxy finishing_gloss 30%



CONCEPTUAL[®] FURNITURE DESIGN

CHORUS
COLLECTION.
Beam.

Technical sheet

Ⓐ . Steel tube frame

■ Steel tube (Diam. 22)

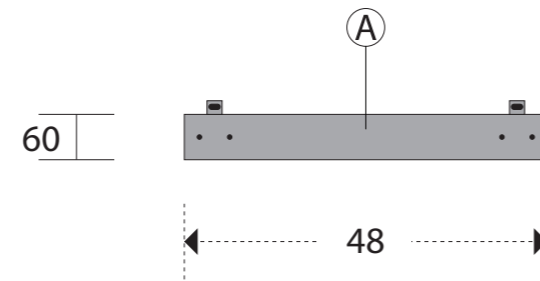

Beam for 1 seater

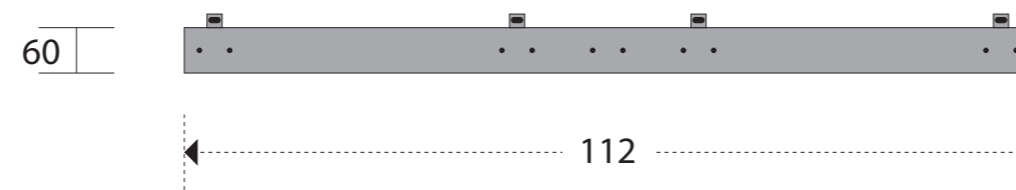

Beam for 2 seater

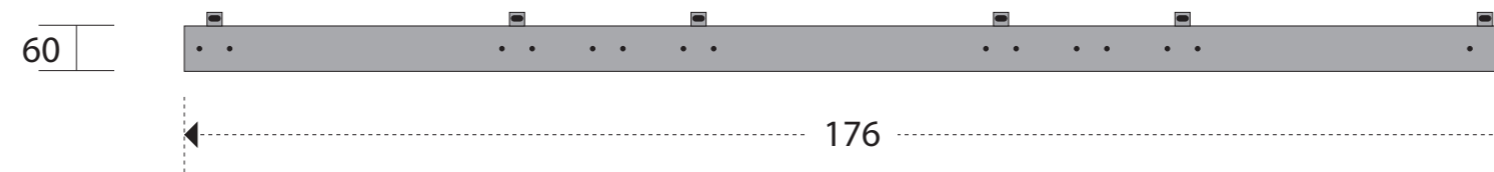

Beam for 3 seater

CHARACTERISTICS

FINISHES

SPECIAL COLOURS AVAILABLE ON REQUEST.

STANDARD POWDER COATING FINISHES

 **White**
RAL 9010
Smooth epoxy finishing_gloss 30%

 **Warm grey**
RAL 7022
Smooth epoxy finishing_gloss 30%

 **Black**
RAL 9005
Smooth epoxy finishing_gloss 30%

CONCEPTUAL[®] FURNITURE DESIGN

CHORUS_Lobby.
COLLECTION.

Technical sheet

- Ⓐ . Steel tube frame
- Ⓑ . Rubber band
- Ⓒ . High density foam
- Ⓓ . Steel tube base
- Ⓔ . solid wood
- Ⓕ . Adjustable feet
- Ⓖ . Low density foam

- Steel tube (Diam. 22)
- ▨ Foam
- ▤ Rubber band

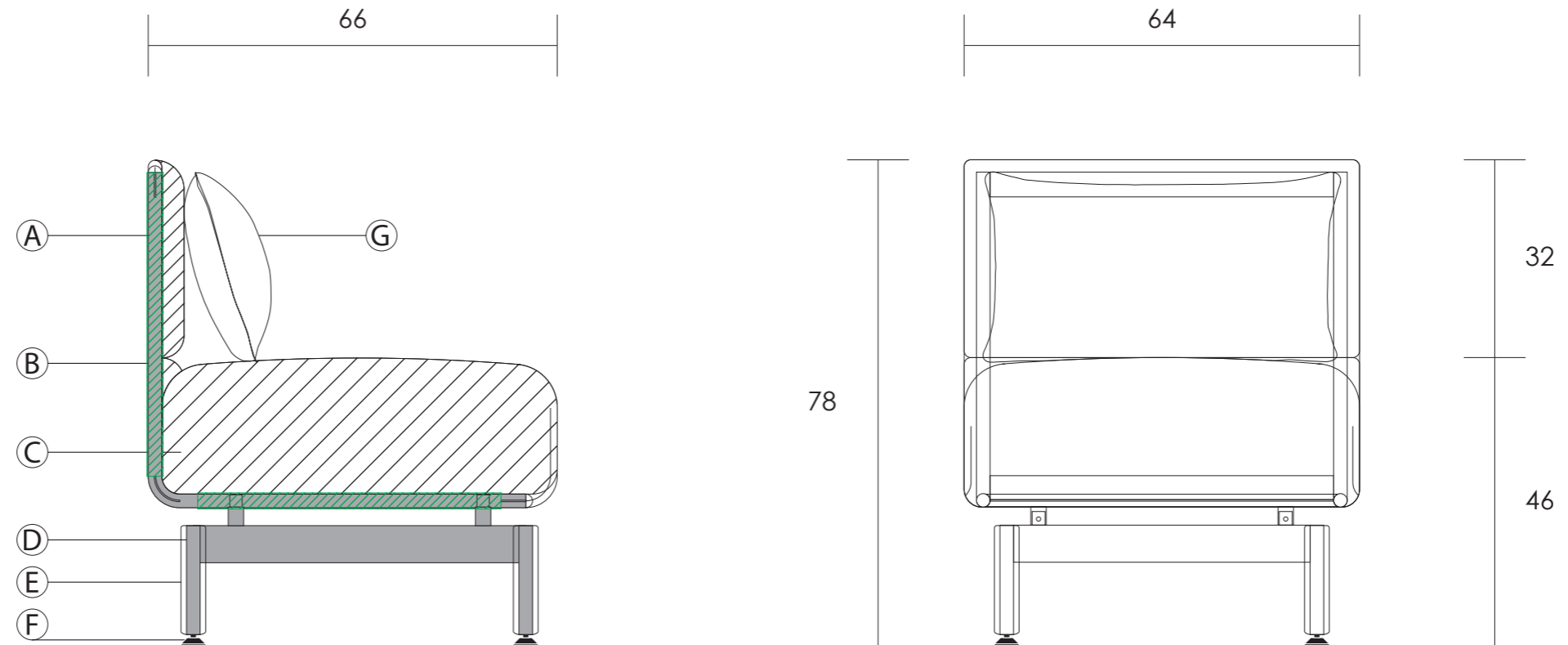

CHARACTERISTICS

FINISHES

SPECIAL COLOURS AVAILABLE ON REQUEST.

SPECIAL COLOURS AVAILABLE ON REQUEST.

STANDARD POWDER COATING FINISHES

STANDARD FINISHES

- 

White
RAL 9010
Smooth epoxy finishing_gloss 30%
- 

Warm grey
RAL 7022
Smooth epoxy finishing_gloss 30%
- 

Black
RAL 9005
Smooth epoxy finishing_gloss 30%

- 

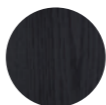
Solid oak
Oiled finish
- 

Solid oak
Stained matt black

CONCEPTUAL[®] FURNITURE DESIGN

CHORUS COLLECTION.

FINISHES

STANDARD TABLE TOP FINISHES

OTHER TOP DECORS AVAILABLE ON REQUEST.



Soft touch white on multiplex (thickness 18 mm).



Soft touch black on multiplex (thickness 18 mm).



Natural oak hpl on multiplex (thickness 18 mm).

OPTIONAL ACCESSORIES

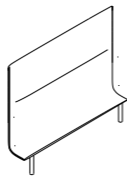

ARMREST LOW

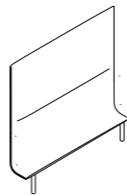

ARMREST HIGH

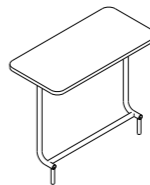

ARMREST TABLE

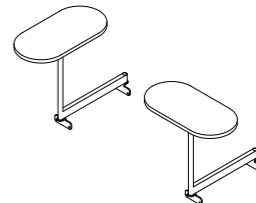

SWIVEL LAPTOP TABLE

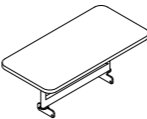

INTERMEDIATE
TABLE SINGLE LOW

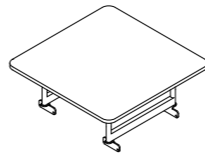

INTERMEDIATE
TABLE DOUBLE LOW

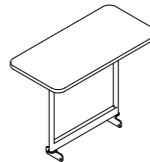

INTERMEDIATE
TABLE SINGLE HIGH

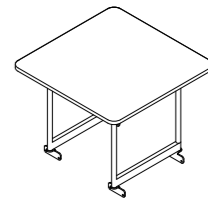

INTERMEDIATE
TABLE DOUBLE HIGH



BEAM POWER SOCKET

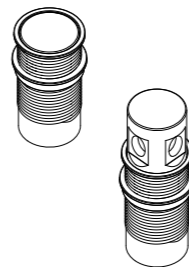

POP-UP POWER SOCKET

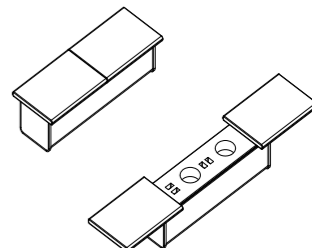

SLIDE POWER SOCKET

CONCEPTUAL[®] FURNITURE DESIGN

CHORUS_Work.
COLLECTION.

Technical sheet

- Ⓐ . Steel tube frame
- Ⓑ . Rubber band
- Ⓒ . High density foam
- Ⓓ . Steel tube base
- Ⓔ . Adjustable feet
- Ⓕ . Low density foam

- Steel tube (Diam. 22)
- ▨ Foam
- ▤ Rubber band

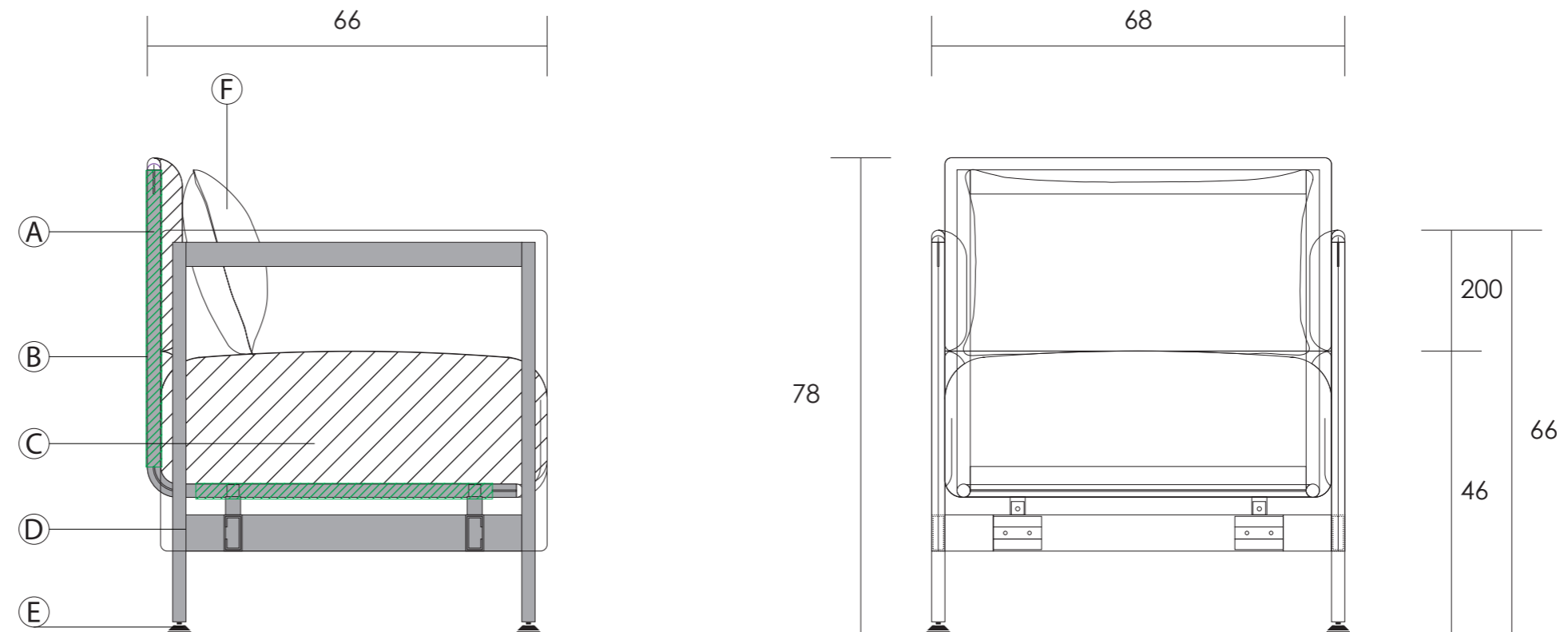



CHARACTERISTICS

FINISHES

SPECIAL COLOURS AVAILABLE ON REQUEST.

STANDARD POWDER COATING FINISHES

- 

White
RAL 9010
Smooth epoxy finishing_gloss 30%
- 

Warm grey
RAL 7022
Smooth epoxy finishing_gloss 30%
- 

Black
RAL 9005
Smooth epoxy finishing_gloss 30%

CONCEPTUAL[®] FURNITURE DESIGN

CHORUS_Work.
COLLECTION.

FINISHES

STANDARD TABLE TOP FINISHES

OTHER TOP DECORS AVAILABLE ON REQUEST.



Soft touch white on multiplex (thickness 18 mm).



Soft touch black on multiplex (thickness 18 mm).



Natural oak hpl on multiplex (thickness 18 mm).

OPTIONAL ACCESSORIES

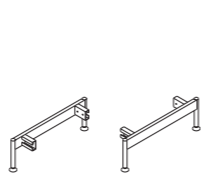

LEGS

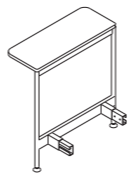

TABLE ARMREST RIGHT

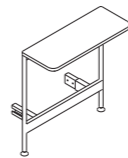
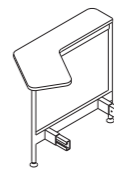
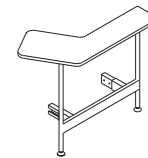

TABLE ARMREST LEFT



LAPTOP TABLE RIGHT



LAPTOP TABLE LEFT

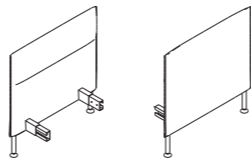

PANEL LOW

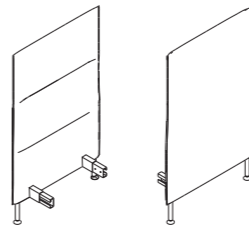

PANEL MEDIUM

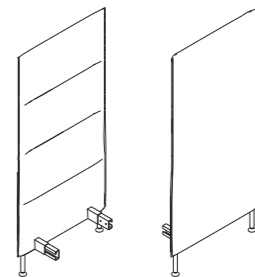

PANEL HIGH

CONCEPTUAL[®] FURNITURE DESIGN

CHORUS_Agile.
COLLECTION.

Technical sheet

- Ⓐ . Steel tube frame
- Ⓑ . Rubber band
- Ⓒ . High density foam
- Ⓓ . Steel tube base
- Ⓔ . Castor base
- Ⓕ . Low density foam

- Steel tube (Diam. 22)
- ▨ Foam
- ▤ Rubber band

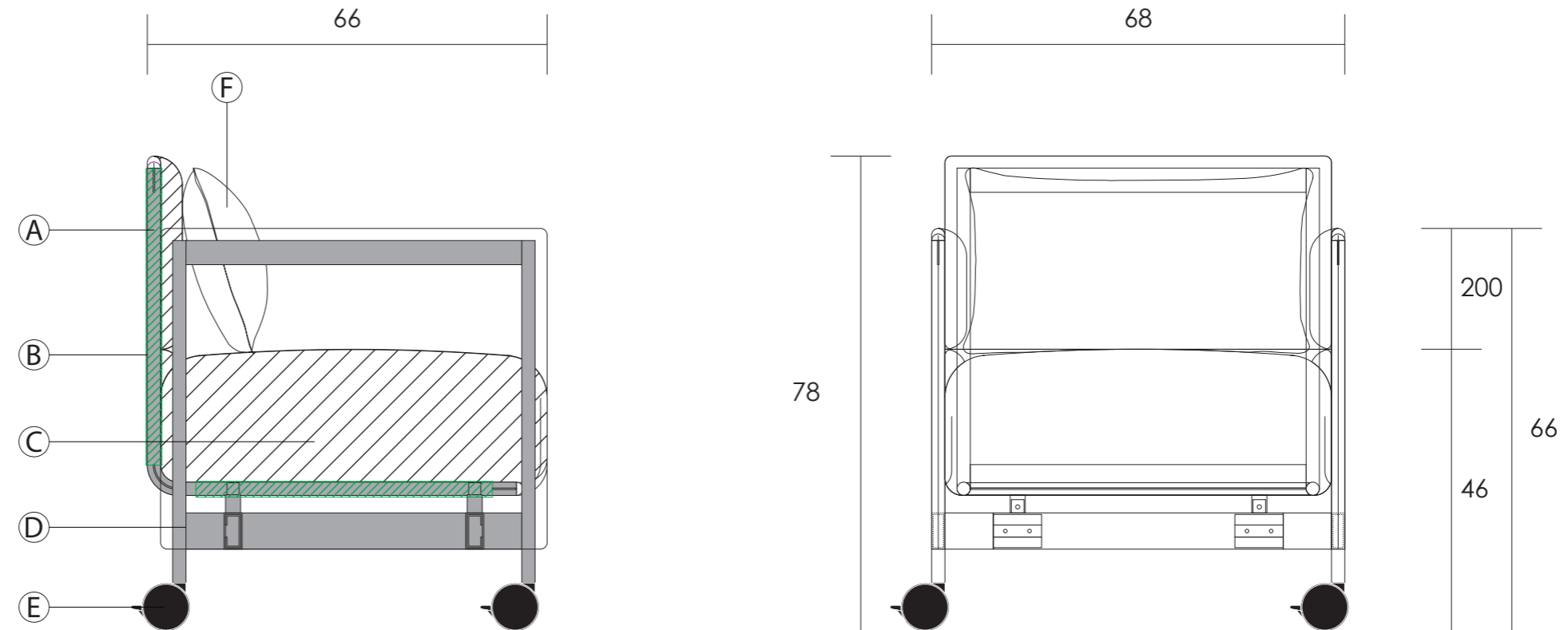



CHARACTERISTICS

FINISHES

SPECIAL COLOURS AVAILABLE ON REQUEST.

STANDARD POWDER COATING FINISHES

- 
White
 RAL 9010
 Smooth epoxy finishing_gloss 30%
- 
Warm grey
 RAL 7022
 Smooth epoxy finishing_gloss 30%
- 
Black
 RAL 9005
 Smooth epoxy finishing_gloss 30%

CONCEPTUAL[®] FURNITURE DESIGN

CHORUS_Agile.
COLLECTION.

FINISHES

STANDARD TABLE TOP FINISHES

OTHER TOP DECORS AVAILABLE ON REQUEST.



Soft touch white on multiplex (thickness 18 mm).



Soft touch black on multiplex (thickness 18 mm).



Natural oak hpl on multiplex (thickness 18 mm).

OPTIONAL ACCESSORIES

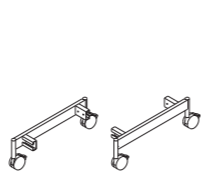

LEGS

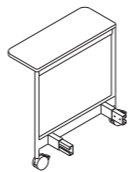

TABLE ARMREST RIGHT

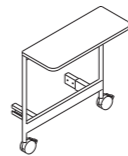
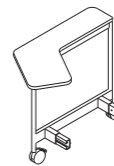

TABLE ARMREST LEFT



LAPTOP TABLE RIGHT



LAPTOP TABLE LEFT

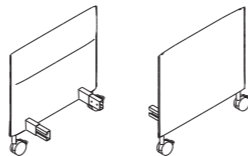

PANEL LOW

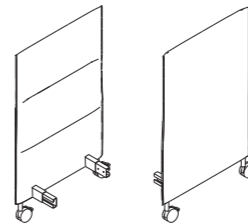

PANEL MEDIUM

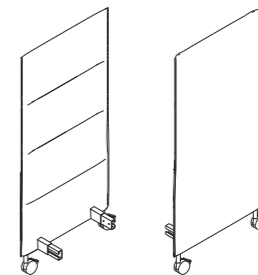

PANEL HIGH

CONCEPTUAL[®] FURNITURE DESIGN

CHORUS_Tables & pods
COLLECTION.

FINISHES

SPECIAL COLOURS AVAILABLE ON REQUEST.

OTHER TOP DECORS AVAILABLE ON REQUEST.

STANDARD POWDER COATING FINISHES

STANDARD TABLE TOP FINISHES

- 

White
RAL 9010
Smooth epoxy finishing_gloss 30%
- 

Warm grey
RAL 7022
Smooth epoxy finishing_gloss 30%
- 

Black
RAL 9005
Smooth epoxy finishing_gloss 30%

- 

Soft touch white on multiplex (thickness 18 mm).
- 

Soft touch black on multiplex (thickness 18 mm).
- 

Natural oak hpl on multiplex (thickness 18 mm).

OTHER SIZES

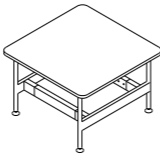

COFFEE TABLE SINGLE

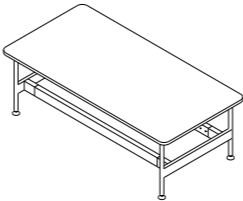

COFFEE TABLE DOUBLE

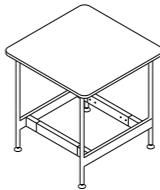

TABLE SINGLE

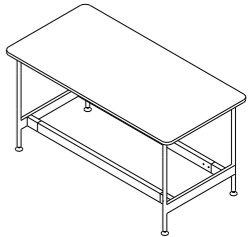
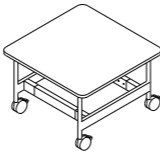
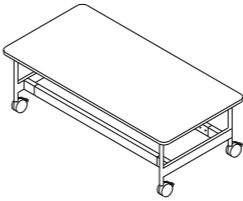

TABLE DOUBLE



COFFEE TABLE CASTORS SINGLE



COFFEE TABLE CASTORS DOUBLE

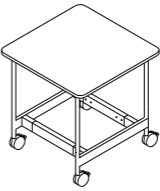

TABLE CASTORS SINGLE

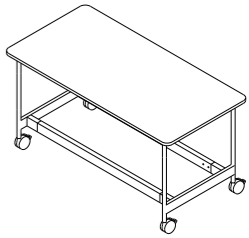
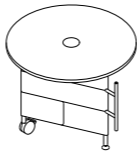
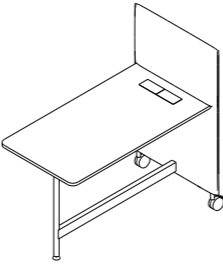

TABLE CASTORS DOUBLE



ELECTRO SERVING TABLE



POD TABLE MID

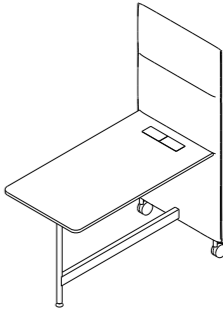



POD TABLE HIGH

CONCEPTUAL[®] FURNITURE DESIGN

CHORUS_Tables. COLLECTION.

Technical sheet

- Ⓐ . Multiplex + melamine
- Ⓑ . Steel tube structure
- Ⓒ . Adjustable feet

-  Multiplex + melamine (18)
-  Steel tube (Diam. 22)



CHARACTERISTICS



FINISHES



SPECIAL COLOURS AVAILABLE ON REQUEST.

OTHER TOP DECORS AVAILABLE ON REQUEST.

STANDARD POWDER COATING FINISHES

STANDARD TABLE TOP FINISHES

-  **White**
RAL 9010
Smooth epoxy finishing_gloss 30%
-  **Warm grey**
RAL 7022
Smooth epoxy finishing_gloss 30%
-  **Black**
RAL 9005
Smooth epoxy finishing_gloss 30%



-  Soft touch white on multiplex (thickness 18 mm).
-  Soft touch black on multiplex (thickness 18 mm).
-  Natural oak hpl on multiplex (thickness 18 mm).

CONCEPTUAL® FURNITURE DESIGN

**CHORUS_Tables.
COLLECTION.**

Technical sheet

- Ⓐ . Multiplex + melamine
- Ⓑ . Steel tube structure
- Ⓒ . Adjustable feet

-  Multiplex + melamine (18)
-  Steel tube (Diam. 22)

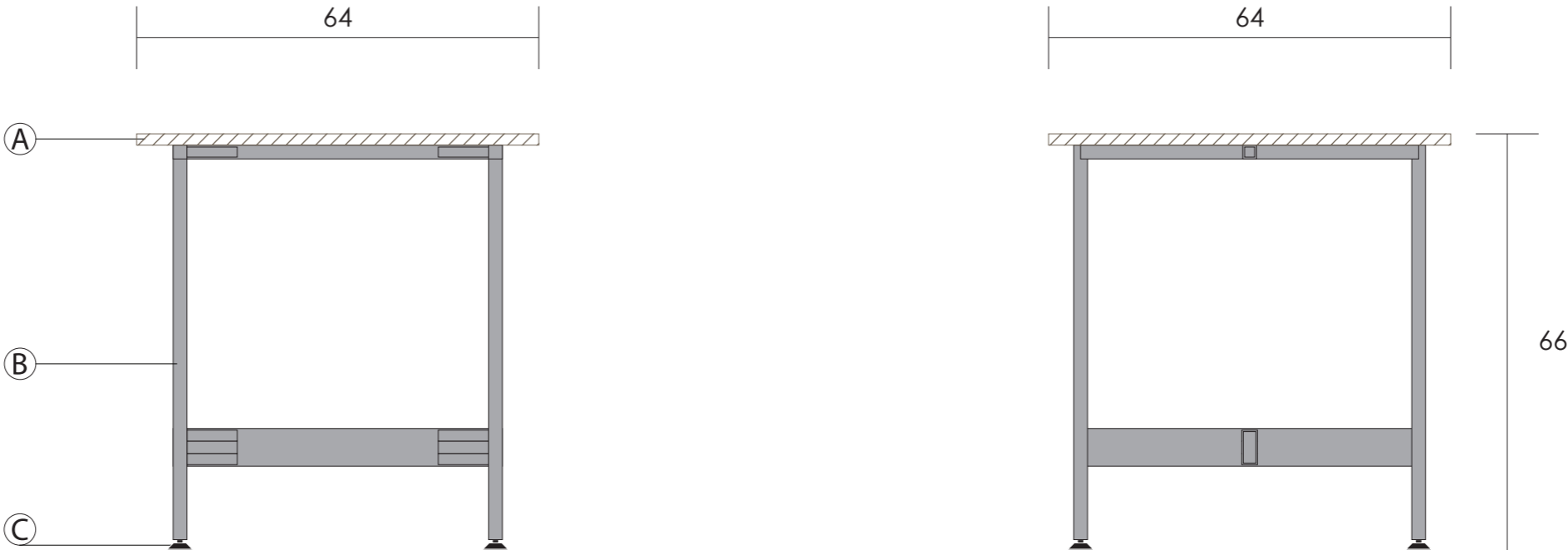

CHARACTERISTICS



FINISHES



SPECIAL COLOURS AVAILABLE ON REQUEST.

OTHER TOP DECORS AVAILABLE ON REQUEST.

STANDARD POWDER COATING FINISHES

STANDARD TABLE TOP FINISHES

-  **White**
RAL 9010
Smooth epoxy finishing_gloss 30%
-  **Warm grey**
RAL 7022
Smooth epoxy finishing_gloss 30%
-  **Black**
RAL 9005
Smooth epoxy finishing_gloss 30%



-  Soft touch white on multiplex (thickness 18 mm).
-  Soft touch black on multiplex (thickness 18 mm).
-  Natural oak hpl on multiplex (thickness 18 mm).

CONCEPTUAL[®] FURNITURE DESIGN

CHORUS_Tables. COLLECTION.

Technical sheet

- Ⓐ . Multiplex + melamine
- Ⓑ . Steel tube structure
- Ⓒ . Adjustable feet

-  Multiplex + melamine (18)
-  Steel tube (Diam. 22)

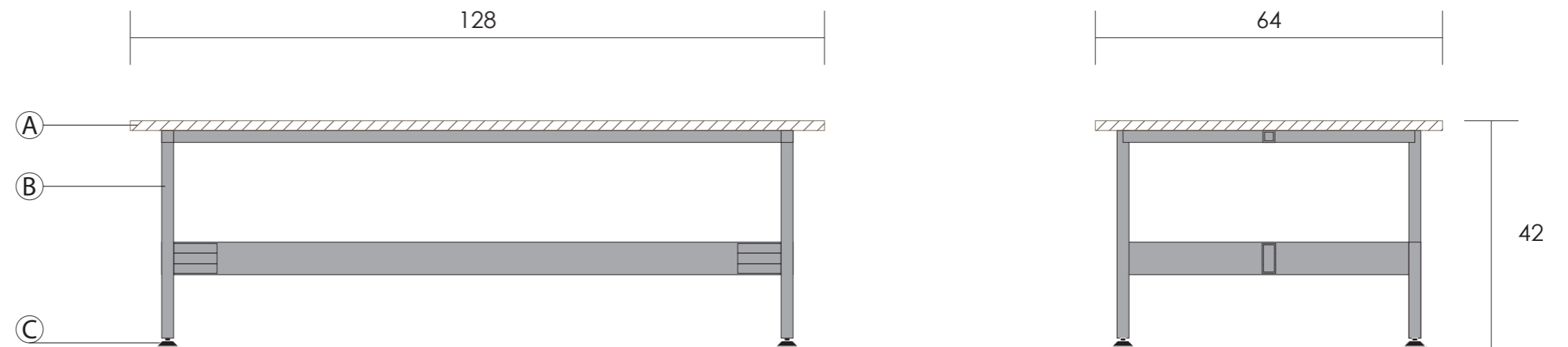

CHARACTERISTICS



FINISHES



SPECIAL COLOURS AVAILABLE ON REQUEST.

OTHER TOP DECORS AVAILABLE ON REQUEST.

STANDARD POWDER COATING FINISHES

STANDARD TABLE TOP FINISHES

-  **White**
RAL 9010
Smooth epoxy finishing_gloss 30%
-  **Warm grey**
RAL 7022
Smooth epoxy finishing_gloss 30%
-  **Black**
RAL 9005
Smooth epoxy finishing_gloss 30%



-  Soft touch white on multiplex (thickness 18 mm).
-  Soft touch black on multiplex (thickness 18 mm).
-  Natural oak hpl on multiplex (thickness 18 mm).

CONCEPTUAL[®] FURNITURE DESIGN

CHORUS_Tables. COLLECTION.

Technical sheet

- Ⓐ . Multiplex + melamine
- Ⓑ . Steel tube structure
- Ⓒ . Adjustable feet

-  Multiplex + melamine (18)
-  Steel tube (Diam. 22)

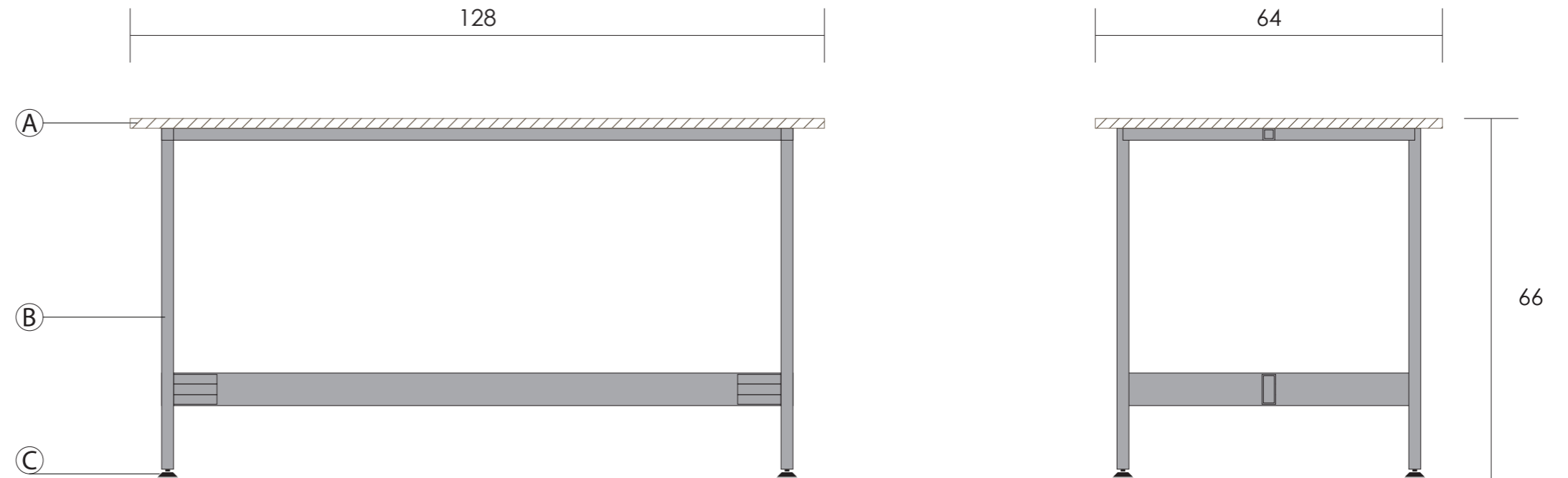

CHARACTERISTICS



FINISHES

SPECIAL COLOURS AVAILABLE ON REQUEST.

OTHER TOP DECORS AVAILABLE ON REQUEST.

STANDARD POWDER COATING FINISHES

STANDARD TABLE TOP FINISHES

-  **White**
RAL 9010
Smooth epoxy finishing_gloss 30%
-  **Warm grey**
RAL 7022
Smooth epoxy finishing_gloss 30%
-  **Black**
RAL 9005
Smooth epoxy finishing_gloss 30%



-  Soft touch white on multiplex (thickness 18 mm).
-  Soft touch black on multiplex (thickness 18 mm).
-  Natural oak hpl on multiplex (thickness 18 mm).

CONCEPTUAL[®] FURNITURE DESIGN

CHORUS_Tables. COLLECTION.

Technical sheet

- Ⓐ . Multiplex + melamine
- Ⓑ . Steel tube structure
- Ⓒ . Castor base

-  Multiplex + melamine (18)
-  Steel tube (Diam. 22)



CHARACTERISTICS



FINISHES



SPECIAL COLOURS AVAILABLE ON REQUEST.

OTHER TOP DECORS AVAILABLE ON REQUEST.

STANDARD POWDER COATING FINISHES

STANDARD TABLE TOP FINISHES

-  **White**
RAL 9010
Smooth epoxy finishing_gloss 30%
-  **Warm grey**
RAL 7022
Smooth epoxy finishing_gloss 30%
-  **Black**
RAL 9005
Smooth epoxy finishing_gloss 30%



-  Soft touch white on multiplex (thickness 18 mm).
-  Soft touch black on multiplex (thickness 18 mm).
-  Natural oak hpl on multiplex (thickness 18 mm).

CONCEPTUAL[®] FURNITURE DESIGN

CHORUS_Tables. COLLECTION.

Technical sheet

- Ⓐ . Multiplex + melamine
- Ⓑ . Steel tube structure
- Ⓒ . Castor base

-  Multiplex + melamine (18)
-  Steel tube (Diam. 22)

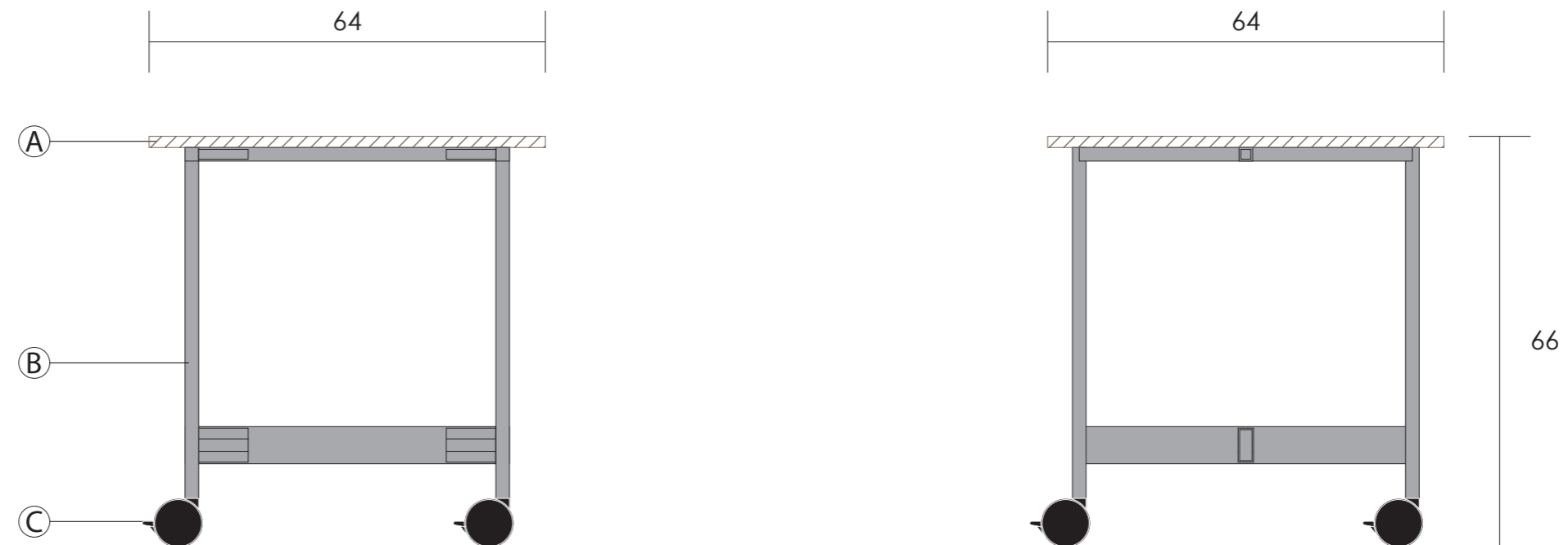

CHARACTERISTICS



FINISHES



SPECIAL COLOURS AVAILABLE ON REQUEST.

OTHER TOP DECORS AVAILABLE ON REQUEST.

STANDARD POWDER COATING FINISHES

STANDARD TABLE TOP FINISHES

-  **White**
RAL 9010
Smooth epoxy finishing_gloss 30%
-  **Warm grey**
RAL 7022
Smooth epoxy finishing_gloss 30%
-  **Black**
RAL 9005
Smooth epoxy finishing_gloss 30%



-  Soft touch white on multiplex (thickness 18 mm).
-  Soft touch black on multiplex (thickness 18 mm).
-  Natural oak hpl on multiplex (thickness 18 mm).

CONCEPTUAL[®] FURNITURE DESIGN

**CHORUS_Tables.
COLLECTION.**

Technical sheet

- Ⓐ . Multiplex + melamine
- Ⓑ . Steel tube structure
- Ⓒ . Castor base

-  Multiplex + melamine (18)
-  Steel tube (Diam. 22)

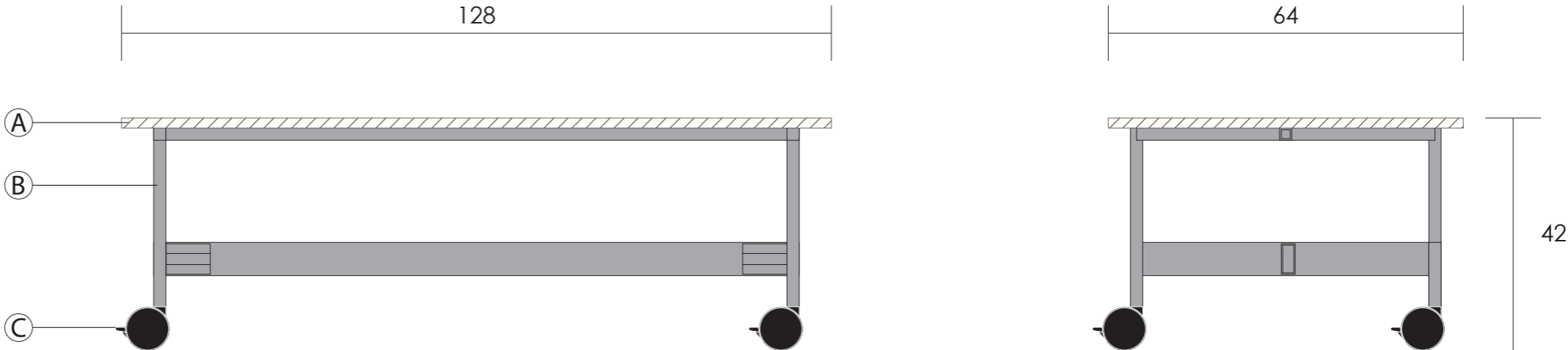

CHARACTERISTICS



FINISHES



SPECIAL COLOURS AVAILABLE ON REQUEST.

OTHER TOP DECORS AVAILABLE ON REQUEST.

STANDARD POWDER COATING FINISHES

STANDARD TABLE TOP FINISHES

-  **White**
RAL 9010
Smooth epoxy finishing_gloss 30%
-  **Warm grey**
RAL 7022
Smooth epoxy finishing_gloss 30%
-  **Black**
RAL 9005
Smooth epoxy finishing_gloss 30%



-  Soft touch white on multiplex (thickness 18 mm).
-  Soft touch black on multiplex (thickness 18 mm).
-  Natural oak hpl on multiplex (thickness 18 mm).

CONCEPTUAL[®] FURNITURE DESIGN

**CHORUS_Tables.
COLLECTION.**

Technical sheet

- Ⓐ . Multiplex + melamine
- Ⓑ . Steel tube structure
- Ⓒ . Castor base

-  Multiplex + melamine (18)
-  Steel tube (Diam. 22)

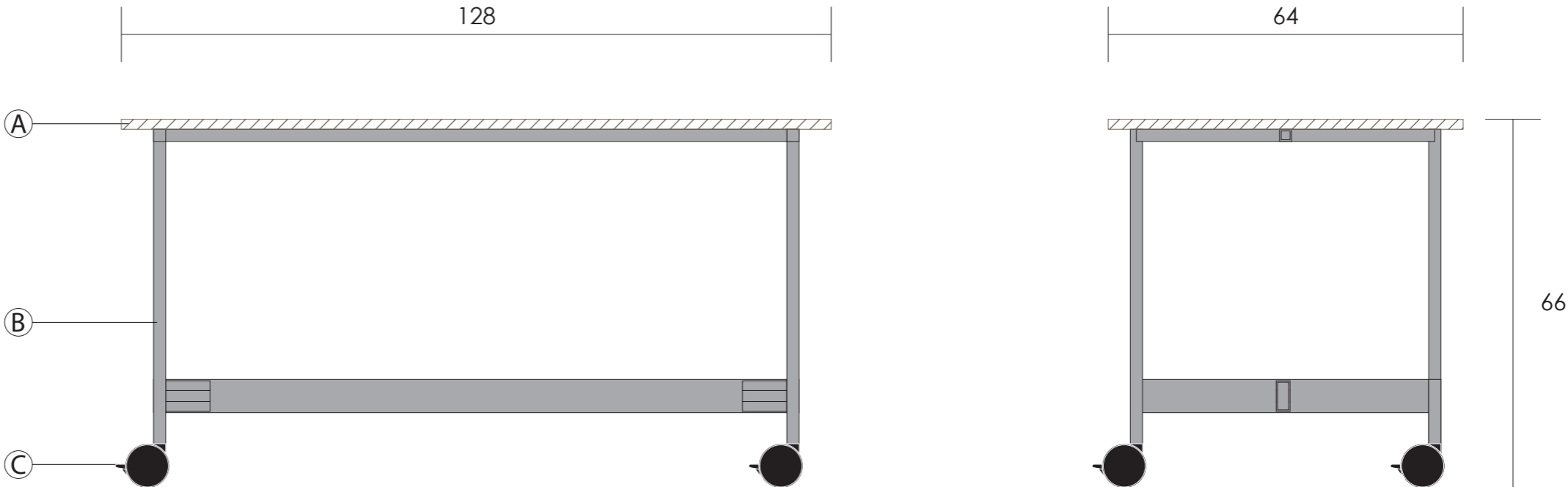

CHARACTERISTICS



FINISHES



SPECIAL COLOURS AVAILABLE ON REQUEST.

OTHER TOP DECORS AVAILABLE ON REQUEST.

STANDARD POWDER COATING FINISHES

STANDARD TABLE TOP FINISHES

-  **White**
RAL 9010
Smooth epoxy finishing_gloss 30%
-  **Warm grey**
RAL 7022
Smooth epoxy finishing_gloss 30%
-  **Black**
RAL 9005
Smooth epoxy finishing_gloss 30%



-  Soft touch white on multiplex (thickness 18 mm).
-  Soft touch black on multiplex (thickness 18 mm).
-  Natural oak hpl on multiplex (thickness 18 mm).

CONCEPTUAL[®] FURNITURE DESIGN

CHORUS_Pods. COLLECTION.

Technical sheet

- Ⓐ . High density foam
- Ⓑ . Steel tube structure
- Ⓒ . Castor base
- Ⓓ . Adjustable feet
- Ⓔ . Multiplex + melamine

-  High density foam
-  Steel tube (Diam. 22)
-  Multiplex + melamine (18)

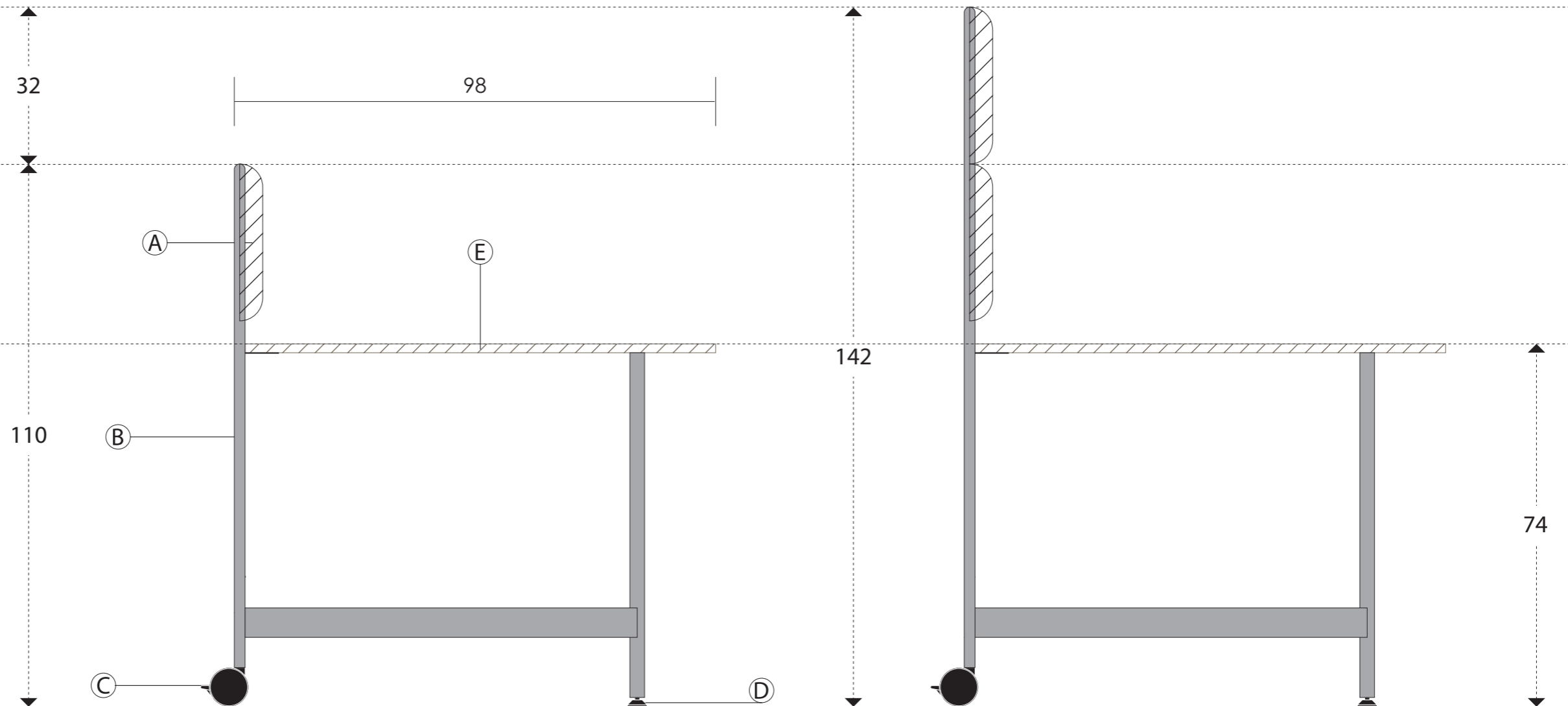

CHARACTERISTICS



FINISHES



SPECIAL COLOURS AVAILABLE ON REQUEST.

OTHER TOP DECORS AVAILABLE ON REQUEST.

STANDARD POWDER COATING FINISHES

STANDARD TABLE TOP FINISHES

-  **White**
RAL 9010
Smooth epoxy finishing_gloss 30%
-  **Warm grey**
RAL 7022
Smooth epoxy finishing_gloss 30%
-  **Black**
RAL 9005
Smooth epoxy finishing_gloss 30%

-  Soft touch white on multiplex (thickness 18 mm).
-  Soft touch black on multiplex (thickness 18 mm).
-  Natural oak hpl on multiplex (thickness 18 mm).

OPTIONAL ACCESSORIES

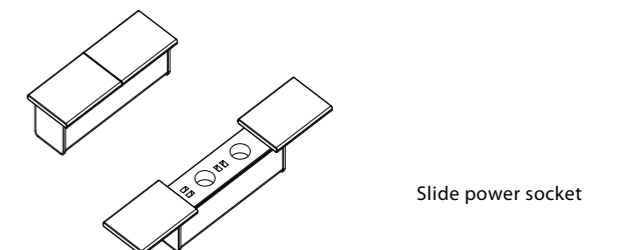



CONCEPTUAL[®] FURNITURE DESIGN

CHORUS
COLLECTION.
Electro serving table

Technical sheet

- Ⓐ . High density foam
- Ⓑ . Steel tube structure
- Ⓒ . Castor base
- Ⓓ . Adjustable feet
- Ⓔ . Multiplex + melamine

-  High density foam
-  Steel tube (Diam. 22)
-  Multiplex + melamine (18)

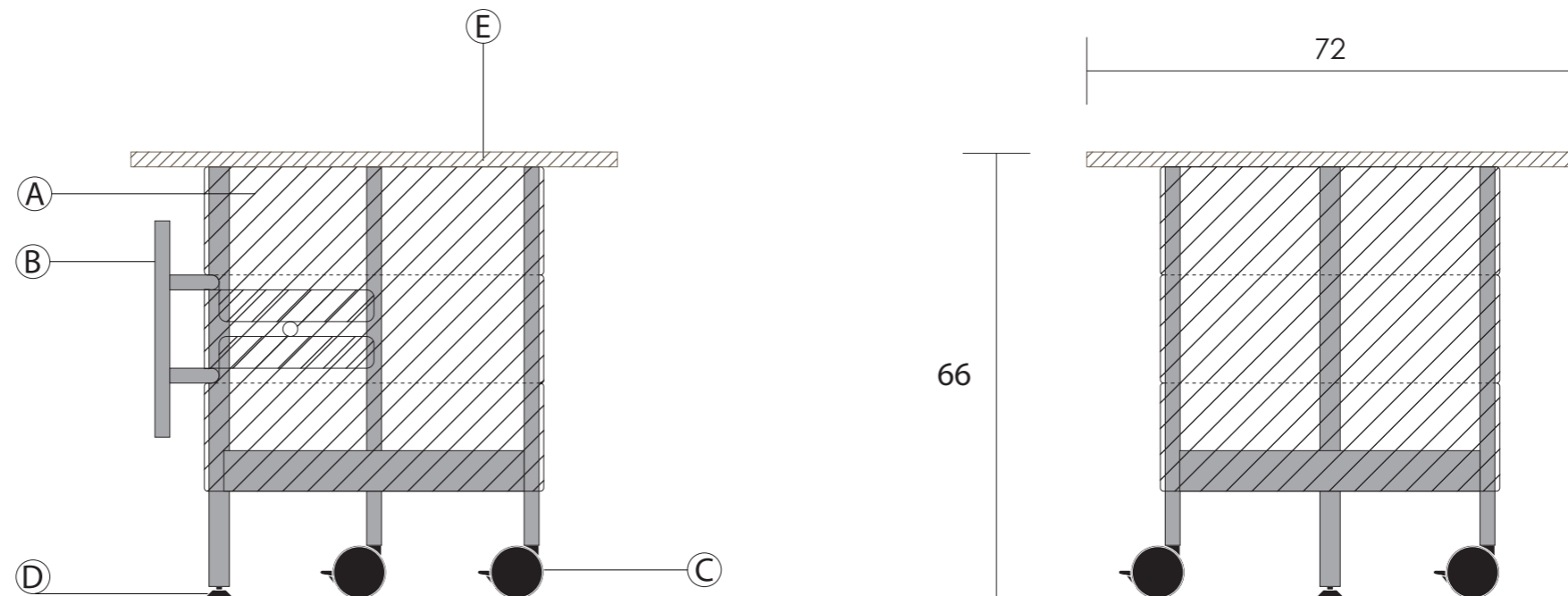

CHARACTERISTICS

FINISHES



SPECIAL COLOURS AVAILABLE ON REQUEST.



OTHER TOP DECORS AVAILABLE ON REQUEST.

STANDARD POWDER COATING FINISHES

STANDARD TABLE TOP FINISHES

OPTIONAL ACCESSORIES

-  **White**
RAL 9010
Smooth epoxy finishing_gloss 30%
-  **Warm grey**
RAL 7022
Smooth epoxy finishing_gloss 30%
-  **Black**
RAL 9005
Smooth epoxy finishing_gloss 30%

-  Soft touch white on multiplex (thickness 18 mm).
-  Soft touch black on multiplex (thickness 18 mm).
-  Natural oak hpl on multiplex (thickness 18 mm).

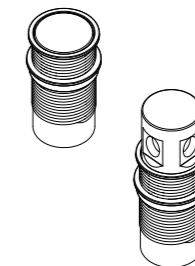

Pop-up power socket